

INSTRUCTION MANUAL

RC OSCILLATOR

MODEL 417C

KIKUSUI ELECTRONICS CORPORATION

Power Requirements of this Product

Power requirements of this product have been changed and the relevant sections of the Operation Manual should be revised accordingly.

(Revision should be applied to items indicated by a check mark)

Input voltage

The input voltage of this product is _____ VAC,
and the voltage range is _____ to _____ VAC. Use the product within this range only.

Input fuse

The rating of this product's input fuse is _____A, _____VAC, and _____.

WARNING

- To avoid electrical shock, always disconnect the AC power cable or turn off the switch on the switchboard before attempting to check or replace the fuse.
- Use a fuse element having a shape, rating, and characteristics suitable for this product. The use of a fuse with a different rating or one that short circuits the fuse holder may result in fire, electric shock, or irreparable damage.

AC power cable

The product is provided with AC power cables described below. If the cable has no power plug, attach a power plug or crimp-style terminals to the cable in accordance with the wire colors specified in the drawing.

WARNING

- The attachment of a power plug or crimp-style terminals must be carried out by qualified personnel.

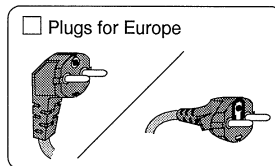
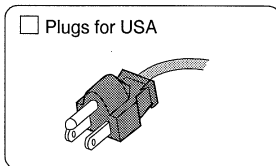
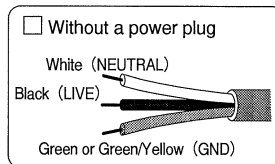
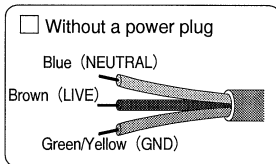

Provided by Kikusui agents

Kikusui agents can provide you with suitable AC power cable.
For further information, contact your Kikusui agent.

Another Cable _____

TABLE OF CONTENTS

	<u>PAGE</u>
1. GENERAL	1
2. SPECIFICATIONS	2
3. OPERATION METHOD	5
3.1 Explanation of Front Panel	5
3.2 Explanation of Rear Panel	7
3.3 Operation Method	7
4. OPERATING PRINCIPLE	13
4.1 Oscillator Circuit	13
4.2 Amplitude Control Circuit	15
5. MAINTENANCE	17
5.1 Access to Internal Chassis	17
5.2 AC Line Voltage Conversion	17
5.3 Adjustments	18
5.4 Layout of Controls	24

* Schematic circuit diagram

1. GENERAL

The 417C is a solid-state Wien-bridge RC oscillator with an overall oscillating frequency range of 5 Hz ~ 500 kHz which is divided into five ranges. The 417C employs an AGC circuit which detects the mean value using an FET for amplitude control in order to provide a stable output of sinusoidal waveform with low distortion.

The 417C is incorporated also with a square-wave generator which employs a Shmitt circuit for producing a square wave of fast rise-up time. The symmetry is adjustable for a range of $\pm 10\%$ or over.

The output level is adjustable for a wide range--for 30 dB with a continuously variable control and for 40 dB with a 10-dB stepwise attenuator.

2. SPECIFICATIONS

Power requirements: 100 V $\pm 10\%$, 50/60 Hz AC, approx. 6 VA
(Convertible to 110/117/220/230/240 V
with internal voltage taps)

Weight: Approx. 5.3 kg (12 lbs.)

Dimensions: 200 W x 140 H x 270 D mm
(7.87 W x 5.51 H x 10.63 D in.)
(Maximum dimensions): 202 W x 163 H x 317 D mm
(7.95 W x 6.42 H x 12.48 D in.)

Ambient temperature: 5 ~ 35°C (41 ~ 95°F)

Oscillating frequency: 5 Hz ~ 500 kHz, 5 ranges

Frequency accuracy: $\pm(3\% + 1 \text{ Hz})$

Output impedance: 600 Ω $\pm 3\%$ (at 1 kHz)

Output attenuator: 30 dB, continuously variable;
10 dB stepwise, maximum 40 dB

Output voltage stability against frequency:
 ± 0.3 dB or better (600 Ω load)

Output voltage stability against temperature: 0.1%/°C or better

Output terminals: 5-WAY type, 19 mm (3/4 in) spacing, floating
operation possible, with 600 Ω internal
terminating resistor

Output waveform: Sinusoidal wave or square wave

Sinusoidal wave output

Output voltage: 3 V rms or over, 600 Ω load, at 5 kHz
(6 V rms or over when open)

Distortion factor:	500 Hz ~ 50 kHz	0.05% or less
	50 Hz ~ 500 Hz	0.1% or less
(with LOW DIST)	10 Hz ~ 50 Hz	0.5% or less
	50 kHz ~ 500 kHz	0.5% or less
	10 Hz and lower	1% or less

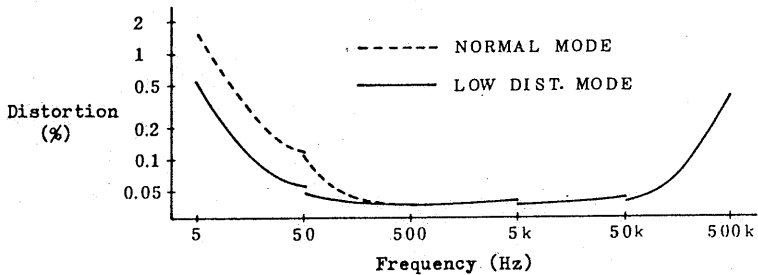

Output voltage maximum, load 600 Ω ,
ambient temperature 25°C (77°F)

Distortion characteristics (typical)

Note: LOW DIST/NORM selection is in $\times 1$ or $\times 10$ range position only.

Square wave output

Output voltage: 6 V p-p or over, 600 Ω load, at 5 kHz
(12 V p-p or over when open)

Variable range of symmetry: $\pm 10\%$ or over

Rise time: 100 nsec or less

Overshoot: 2% or less, at maximum output voltage

Sag: 10% or less, at 5 Hz

Output voltmeter

Scale: V rms and dBm, 3 V rms full scale

Accuracy: $\pm 3\%$ or better of full scale, at 1 kHz
sinusoidal wave

Ext SYNC input: $\pm 7\%$ or over with sinusoidal input voltage
6 V rms or over. (Sync range is roughly
proportional to input voltage.)

No distortion factor change or output voltage
change with sinusoidal input voltage 0.5 V
rms or less.

Accessory: Instruction manual 1

3. OPERATION METHOD

3.1. Explanation of Front Panel

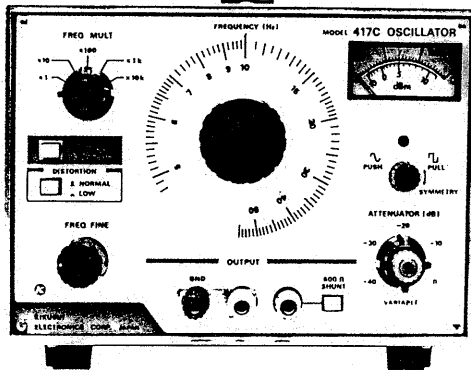

POWER: When depressed and locked, the instrument power turns on and the power pilot lamp lights.

FREQUENCY: With this dial the oscillating frequency is continuously variable to a factor of 10 times.

FREQ MULT: Selects the multiplication factor of the oscillating frequency. The instrument oscillates at a frequency of the FREQUENCY dial reading multiplied by the factor selected by this switch.

ATTENUATOR: Attenuates the output voltage in 10-dB steps, up to 40 dB maximum.

VARIABLE: Continuously variable adjustment of output voltage.

OUTPUT: Output terminals of red, white, and black (GND). The white terminal is connected to the internal chassis but is isolated from the casing. When the output is required to be floated from the GND line, disconnect the jumper bar.

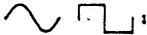

This switch selects the output waveform between sinusoidal wave (depressed state) and square wave (pulled out state). By turning this knob in the pulled out state, symmetry of the square wave can be adjusted.

600 Ω SHUNT: When this button is depressed, the output circuit is terminated with 600-ohm internal resistor.

OUTPUT METER: Indicates the output voltage with the ATTENUATOR set at 0 dB. The upper scale is in V rms and the lower scale in dBm.

DISTORTION: When set in the LOW state, waveform distortion with the $\times 1$ or $\times 10$ RANGE is reduced although a longer restoration time is required after turning the FREQUENCY dial or the RANGE switch, than when set in the NORM state.

NORM

LOW

3.2 Explanation of Rear Panel

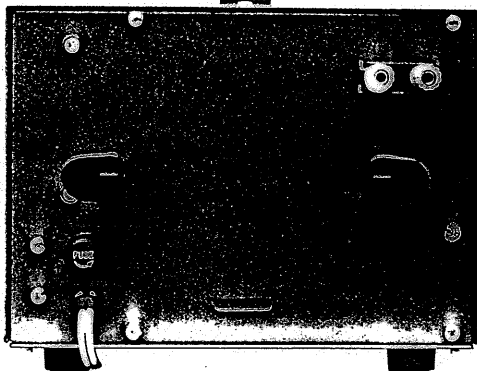

EXT SYNC: Input terminal for external signal with which
 the oscillating frequency is to be synchronized.

FUSE: Fuse of the AC input power line. (See Section 5.2.)

3.3 Operation Method

(1) Turning on the power:

Depress and lock the POWER switch. The pointer on the dial plate will light and the instrument will become the operating state in several seconds.

(2) Setting the oscillating frequency:

Set the oscillating frequency with the **FREQ MULTI** switch and **FREQUENCY** dial. The oscillating frequency corresponds to the setting of the **FREQUENCY** dial multiplied by that of the **FREQ MULTI** switch.

(3) Output voltage:

Match the impedance of the instrument to be connected to the output terminal of the oscillator with that (600 ohms) of the oscillator. When the impedance of the instrument to be connected to the oscillator is sufficiently large as compared with that of the oscillator, impedance matching can be accomplished simply by depressing the **600 Ω SHUNT** button. If the oscillator is operated in a mismatched state, the output voltmeter may not indicate accurately the output voltage.

When the output impedance is matched, the required voltage can be set with the **VARIABLE** and **ATTENUATOR** knobs, and a voltage which is attenuated by the value indicated by the **ATTENUATOR** knob from the output voltmeter reading can be obtained.

It is possible to adjust the output voltage to 0 V with the **VARIABLE** knob alone. When the output voltage is reduced

to -10 dBm or lower with the VARIABLE knob alone, however, the signal waveform is degraded. Avoid using this knob at a level the output voltmeter indication is less than 20% of full scale.

The output voltmeter indicates the signal voltage of either sinusoidal wave or square wave. Of the square wave, however, the output voltmeter can be used only when the waveform symmetry is 1.

(4) Synchronization

The oscillating frequency of the oscillator can be synchronized to an external synchronization signal applied to the EXT SYNC terminal.

When the external synchronization signal frequency is close to the set frequency of the oscillator or when the external signal is abundant in harmonics and the set frequency of the oscillator is an integer times of the external signal, the oscillator oscillates being synchronized with the external signal. The synchronized state varies depending on the voltage and frequency of the external signal. The synchronizable frequency shift of the external signal is roughly proportional to the external signal voltage.

When the external synchronization signal is a small voltage of sinusoidal wave, the output signal distortion caused by synchronization is small. The distortion increases as the external synchronization signal voltage increases and as the difference between the set frequency of the oscillator and the external synchronization signal frequency increases.

When the external synchronization signal is abundant in harmonics, synchronization can be effected even with the 10th or a higher harmonic frequency, although the signal distortion may increase.

The EXT SYNC terminal can also be used for the following purposes:

- (A) For obtaining an output signal of accurate frequency and low distortion, in synchronization with a crystal oscillator, a tuning fork, or other device the frequency of which is very accurate.
- (B) For obtaining an output signal of small distortion and of the same frequency from a signal of large distortion.
- (C) For obtaining signals synchronized to fundamental wave and harmonic waves, using two or more oscillators for the following operations:

- (a) Stationary Lissajous figures can be readily displayed with an oscilloscope. While stationary patterns can hardly be obtained at such an odd ratio as 5:3 or 10:3, stationary patterns can be readily obtained by effecting synchronization.
- (b) A synthesized waveform can be obtained by adding the output signals of two or more oscillators.
- (c) A pulse signal which is leading or lagging with respect to the reference pulse signal can be obtained and the pulse interval can be varied.

(5) Sinusoidal wave output:

At the $\times 1$ or $\times 10$ range, the DISTORTION switch may be selected between NORM and LOW according to the type of measurement. The NORM state may be used when distortions to some extent are permissible as is the case in frequency measurement; the LOW state may be used when a low-distortion signal is required. Note, however, that, in the case the switch is set in the LOW state, a longer period is required by the signal amplitude for stabilizing after turning the frequency dial as compared with the case the switch is set in the NORM state.

(6) Square wave output:

The symmetry is adjustable by turning the $\sim \square$ button. If the output voltage is small, the rate of overshoot is large. To obtain a better waveform, operate the oscillator with as large output voltage as possible.

(7) Conditions of use:

- * The ambient temperature range for normal operation is $5 \sim 35^{\circ}\text{C}$ ($41 \sim 95^{\circ}\text{F}$). Note that, even when the ambient temperature is not higher than 35°C (95°F), the internal temperature may become intolerably high if the instrument is subjected to direct sunlight or radiation from a heat source.
- * As the Wien-bridge circuit uses a high resistor ($38 \text{ M}\Omega$) for the range, avoid using the instrument in a dusty or highly humid atmosphere whenever avoidable.
- * Note that, when the instrument is operated in the floating mode at the $\times 1$ frequency range, the output signal may be slightly affected by the AC line frequency.

4. OPERATING PRINCIPLE

4.1 Oscillator Circuit

For low frequency oscillators, oscillators with R and C as the frequency controlling elements are popular. Among these RC oscillators, Wien-bridge oscillators are most popular. The Wien-bridge oscillators have such advantages that the oscillation is stable, the oscillating frequency is easily variable and a signal of less distortion is obtained.

This instrument also employs a Wien-bridge oscillator circuit as shown in Figure 4-1.

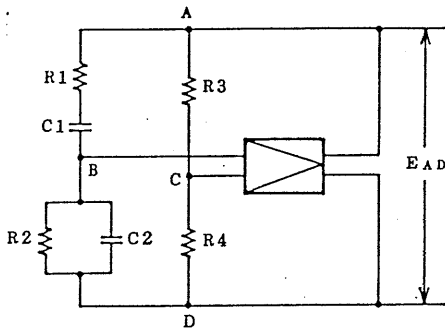

Figure 4-1

Referring to Figure 1, E_{BC} becomes the same phase with E_{AD} when there exists the following condition:

$$f = \frac{1}{2\pi\sqrt{R_1 R_2 C_1 C_2}} \dots\dots\dots (1)$$

The circuit oscillates when there exists the following condition:

$$E_{BC} = \left(\frac{1}{1 + \frac{R1}{R2} + \frac{C2}{C1}} - \frac{R4}{R3 + R4} \right) E_{AD} \dots\dots (2)$$

$$\frac{1}{1 + \frac{R1}{R2} + \frac{C2}{C1}} - \frac{R4}{R3 + R4} \geq \frac{1}{A} \dots\dots (3)$$

The circuit is stabilized when the following state is attained:

$$\frac{1}{1 + \frac{R1}{R2} + \frac{C2}{C1}} - \frac{R4}{R3 + R4} = \frac{1}{A} \dots\dots\dots (4)$$

It is hardly possible to satisfy always the state of equation (4) with the circuit of Figure 1. If this state exists from the beginning, the circuit cannot start oscillating. The condition for oscillation is not related to the amplitude as can be seen in equation (1) or (3).

With an acutal oscillator circuit, the oscillation builds up under the condition of equation (3) until the amplitude expressed with equation (4) is obtained. For this operation, resistor R3 or R4 of Figure 1 is required to vary automatically in response to the amplitude. This requirement can be met in various ways. The most popular method is to use a thèrmistor for resistor R3.

The use of a thermistor is advantageous in that the circuit is simple and the state of equation (4) is satisfied even when circuit constants have varied substantially. It is disadvantageous, however, in that the operation is affected by ambient temperature and a longer stabilization period is required to obtain a signal of low distortion.

This instrument employs such circuitry that an average value of the oscillation voltage is detected and the gate voltage of an FET is controlled with the average voltage in order that an output of very low distortion and high amplitude stability against temperature change is obtained.

4.2 Amplitude Control Circuit

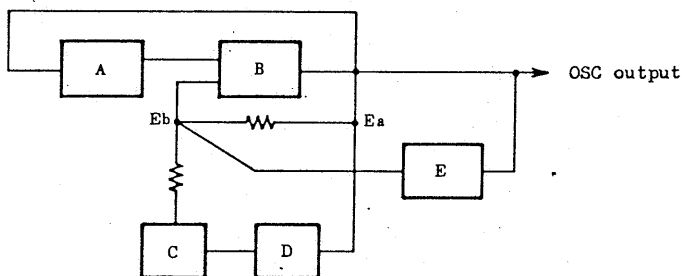

- A: Wien-bridge
- B: Amplifier
- C: Voltage control variable-resistance circuit
- D: Rectifier for AGC
- E: Transient suppression circuit

Figure 4-2

Circuit D rectifies the oscillation voltage to provide a DC voltage. As the oscillation voltage increases, the DC voltage increases. Circuit D is so designed that its resistance varies in response to the DC voltage. As the voltage increases, the resistance increases and E_b/E_a also increases. As E_b/E_a increases, the feedback rate of circuit B increases, and the oscillation voltage decreases. The circuit balances at a certain voltage, attaining the state of equation (4).

Even when a bridge element or the gain of circuit B has varied, the resistance of circuit C so varies that the oscillator circuit remains in the stabilized state maintaining the state of equation (4).

Circuit E suppresses sharp change of oscillation output voltage which could be caused when the frequency range is switched or the oscillating frequency is rapidly changed. When the oscillation voltage tends to increase sharply, the feedback rate rapidly increases in order to suppress the amplitude change.

5. MAINTENANCE

5.1 Access to Internal Chassis

To gain access to the internal chassis, undo the six clamping-screws (M3) of the main-unit cover and remove the cover by pulling it upward.

Note: Remove the cover in an atmosphere where is reasonably free of dust (especially of metallic dust).

5.2 AC Line Voltage Conversion

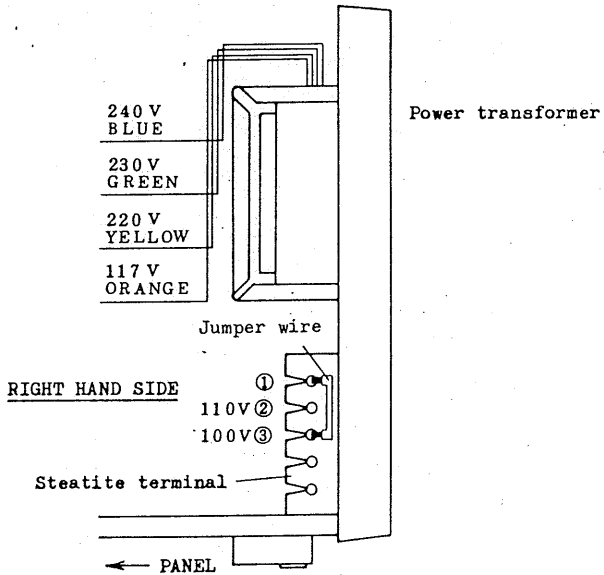

Figure 5-1

(1) The connections shown in Figure 5-1 is for the 100 V AC line power.

(2) Conversion for 110 V AC:

Disconnect the jumper wire from between terminals (1) and (3), and jumper between terminals (1) and (2).

(3) Conversion for 117 V, 220 V, or 240 V AC:

Disconnect the jumper wire. Connect the transformer tap wire of the required voltage (color coded) to terminal (1).

Notes: 1. Do not change the wires other than the specified ones.

2. When the AC line voltage is changed, change the fuse also as mentioned below. Indicate the voltage and fuse rating as required. (An indicating plate is supplied accompanying the instrument.)

* 100 V, 110 V, 117 V AC	0.5 A
* 220 V, 230 V, 240 V AC	0.3 A

5.3 Adjustments

Make adjustments referring to the following items and Figures 5-2 ~ 5-5.

- (1) Adjustments of DC supply voltages (+15 V and -15 V):

Adjust the voltages of test points TP4 and TP3 of printed circuit board (A2) with respect to the ground at an accuracy of $\pm 2\%$ with respective potentiometers (+15 V and -15 V).

- (2) GAIN adjustment:

Set the FREQ MULT at $\times 1K$ and the dial at 5. Connect the fork pin as shown in Figure 5-2A. So adjust the GAIN control that the voltage of TP1 becomes $-0.7\text{ V} \pm 10\%$ as measured with a voltmeter of 10 M Ω or higher input resistance. Then, return the fork pin to the original state.

- (3) Output voltage adjustment:

Set the output waveform at sinusoidal wave, the ATTENUATOR at 0, the VARIABLE in the extremely clockwise position, and so set that a 600-ohm load is connected to the output terminal. So adjust the OUT LEVEL control that the voltage at the output terminal becomes 3.3 V rms. If the amplitude is unstable, turn the DAMP (LEVEL) control clockwise to a position where the amplitude is stabilized.

(4) Damping balance adjustment:

Observe the signals of TP2 and TP3 using an oscilloscope.

Waveforms as shown in the following will be displayed.

So adjust the DAMP (\pm) control that a state of $e_1 = e_2$ is obtained.



(5) Damping level adjustment:

So adjust the DAMP (LEVEL) control that a state of $e_1 = e_2$
 $= 40 \text{ mV} \pm 2 \text{ mV}$ for Para. (4) is obtained.

(6) DC LEVEL adjustment:

Set the VARIABLE knob in the extremely counterclockwise position. So adjust the DC LEVEL control that the output terminal signal voltage becomes $0 \pm 1 \text{ mV}$.

(7) DC BALANCE adjustment;

Connect the fork pin as shown in Figure 5-2B. Set the VARIABLE knob in the extremely clockwise position and so adjust the DC BAL control that the output terminal voltage becomes $0 \pm 1 \text{ mV}$. After the adjustment is over, return the fork pin to the position shown in Figure 5-2.

(8) Distortion adjustment:

Measuring the output distortion, so adjust the DIST control that the distortion becomes 0.03% or less (5 kHz).

(9) Repeat the adjustments of (2), (3), (4) and (5).

(10) Frequency adjustment:

(10)-1 Dial plate position setting:

Measuring at the frequencies of 50 Hz, 500 Hz, 5 kHz and 50 kHz which are corresponding to dial scale 5 and FREQ MULT switch settings $\times 10$, $\times 100$, $\times 1k$ and $\times 10K$, adjust the FREQUENCY dial to a position where the errors of the frequencies become minimum. Loosen the setscrew of the dial knob and fix it in the state that the above requirement is met.

(10)-2 Set the FREQ MULT switch in the $\times 1k$ position. Under this state, measure the voltage of TPl and note this voltage as E_{TPl} (2 ~ 5 V DC).

(10)-3 Leaving the dial indication in the above state and measuring the frequencies for the $\times 10$, $\times 100$ and $\times 1k$ position of the FREQ MULT switch, so adjust A3C6 and A3C9 that the errors of the frequencies become minimum and the voltage of TPl becomes E_{TPl} .

(10)-4 Set the FREQ MULT switch in the $\times 10k$ and the FREQUENCY dial in the 50 position. Measuring the frequency under this state, so adjust the HF trimmer capacitor that the frequency becomes 500.0 kHz.

(11) Output voltage frequency characteristics:

Set the FREQUENCY dial in the 40 position and the FREQ MULT switch in the $\times 100$ position, and measure the output terminal voltage. Change the FREQ MULT switch to the $\times 10k$ position and so adjust the OUT LEVEL (C) control that the output terminal voltage becomes the same value as above.

(12) Distortion adjustment for high frequency range:

Set the FREQUENCY dial in the 5 position and the FREQ MULT switch in the $\times 10k$ position. Measuring the distortion, so adjust the DIST (C) control that the distortion becomes minimum.

(13) Symmetry adjustment of square wave:

Set the FREQ MULT switch in the $\times 100$ position and the waveform selector switch in the square wave position. Observing the signal waveform on an oscilloscope, so adjust the SYM control that a state of $A = B$ in the following illustration is obtained when the waveform selector switch is turned to the extremely clockwise position and to the extremely counterclockwise position.

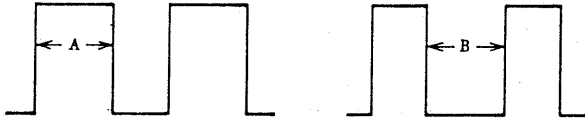

(14) Adjustment of meter circuit:

Set the FREQ MULT switch in the $\times 100$ position and the waveform selector switch in the sinusoidal wave position. Measuring the output terminal voltage, adjust the output voltage at 3 V rms by means of the VARIABLE knob. Under this state, so adjust the METER control that the meter indicates 3 V.

Next, turn the FREQ MULT switch to the $\times 10k$ position and adjust the METER (C) control in a similar manner as above.

5.4 Layout of Controls

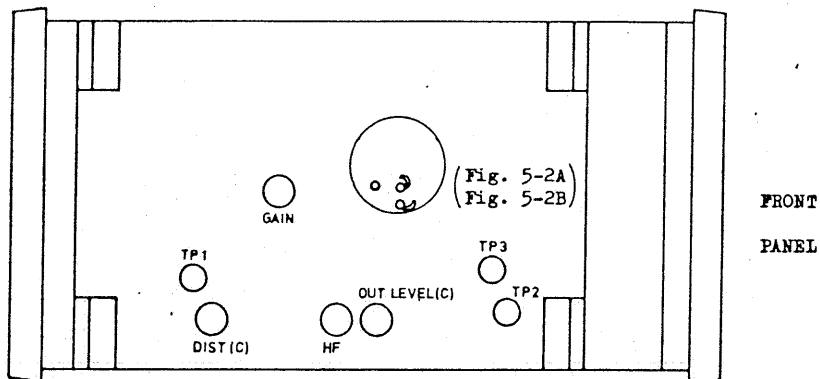

Figure 5-2 (left side panel)



Figure 5-2A



Figure 5-2B

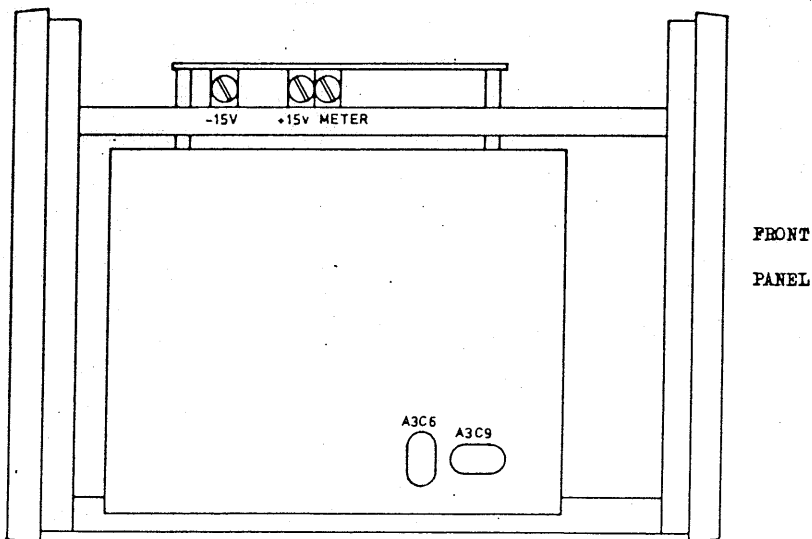

Figure 5-3 (top panel)

FRONT
PANEL

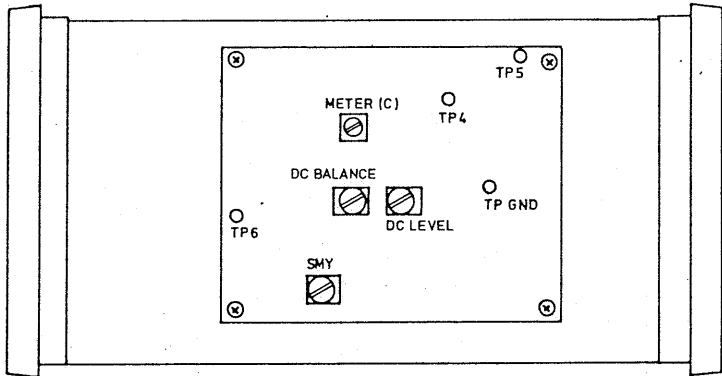

Figure 5-4 (right side panel)

FRONT
PANEL

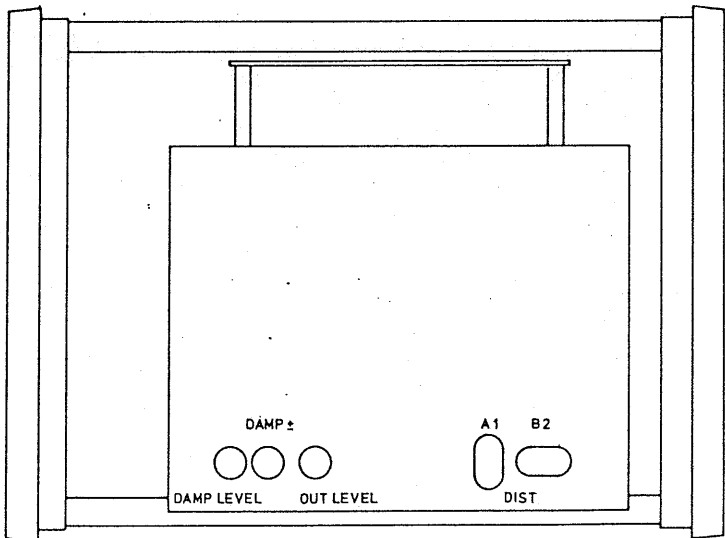

Figure 5-5 (bottom panel)